



Vossoh-Schwabe Programmer
User Manual

V1.2



CONTENTS

1. Preface	1
1.1. Objective	1
1.2. Programmable LED driver product family	1
2. Introduction to programmer hardware and software	1
2.1. Introduction to the Programmer Panel	1
2.2. The programmer is wired to the LED driver	2
3. Software installation and use	4
3.1. Operating system requirements	4
3.2. Software installation	4
3.2.1. Software decompression	4
3.2.2. Driver installation	5
3.3. Functional description of the software	5
3.3.1. Software main interface	5
3.3.2. Window area description	7
3.4. Programmer firmware upgrade	8
3.5. Online programming and offline programming	9
3.5.1. Online programming	9
3.5.2. Offline programming	10



4. Introduction to programmable LED driver functions.....	11
4.1. Programmable LED driver functions.....	11
4.2. Programmable LED driver functions explained in detail.....	12
4.2.1. Work Current Setting.....	12
4.2.2. 3in1 Dimming.....	13
4.2.3. Timer Dimming.....	13
4.2.4. Software Start Adjustable.....	14
4.2.5. End Life Alarm.....	15
4.2.6. Constant Lumen Output.....	16
4.2.7. NTC Protection.....	17
4.2.8. Model Parameters.....	21
4.3. Introduction to the adaptive timer function.....	22
4.3.1. Adaptive timer function application.....	22
4.3.2. Adaptive time calculation.....	22
4.3.3. Adaptive timer dimming.....	23

1. Preface

1.1. Objective

Helps users proficiency in using Vossoh-Schwabe Programmer programming software, programmer connection, and quickly set up LED driver functions.

1.2. Programmable LED driver product family

VP series, M series, VB series, VP-H series, VA series, VA-T series, VH series, VH-E series, PA series, etc.

2. Introduction to programmer hardware and software

2.1. Introduction to the Programmer Panel



The wiring sequence from top to bottom is: DIM-, VCC+, DIM+.

After the LED driver is connected, the programmer is powered on and can be operated by the "-" "+" "P" three keys (the "-" "+" key is used only as a fine adjustment).

The function of the button "-" is to reduce the current output by up to 10%. With one

click, reduce the ratio to 0.5% of the maximum output current of the LED driver.

The function of the button "+" is to increase the current output by up to 10%; with one click, the proportion of the increase is 0.5% of the maximum output current of the LED driver,

The function of the button "P" is used for offline programming. You can write the internal model information of the programmer to the LED driver and modify the LED driver settings. When using offline programming, the internal model of the programmer must be the same as the LED driver model.

2.2. The programmer is wired to the LED driver



Dimming colors may change, and it is best to distinguish the wiring order according to the label of the programmer and LED driver:

“Programmer : DIM-” is connected to “LED driver: DIM-” .



“Programmer : VCC+” is connected to “LED driver: VCC+” .

“Programmer : DIM+” is connected to “LED driver: DIM+” .

The programmer is connected to the computer's USB port, and the programmer recognizes the LED driver.

Connection correct: "di" sound.

Programmer connection to LED driver failed: continuous "dididi~dididi~..." sound.

Programmer does not match the LED driver software version: "didididi" sound.

2.3. In specific cases, if the AC is disconnected, it can be programmed, but the AC cannot be programmed when it is opened. Between "DIM+" and "DIM-", a capacitor in the range of 473 to 104 (47nf to 100nf) is connected in parallel. Excessive capacitance can also cause programming failures.

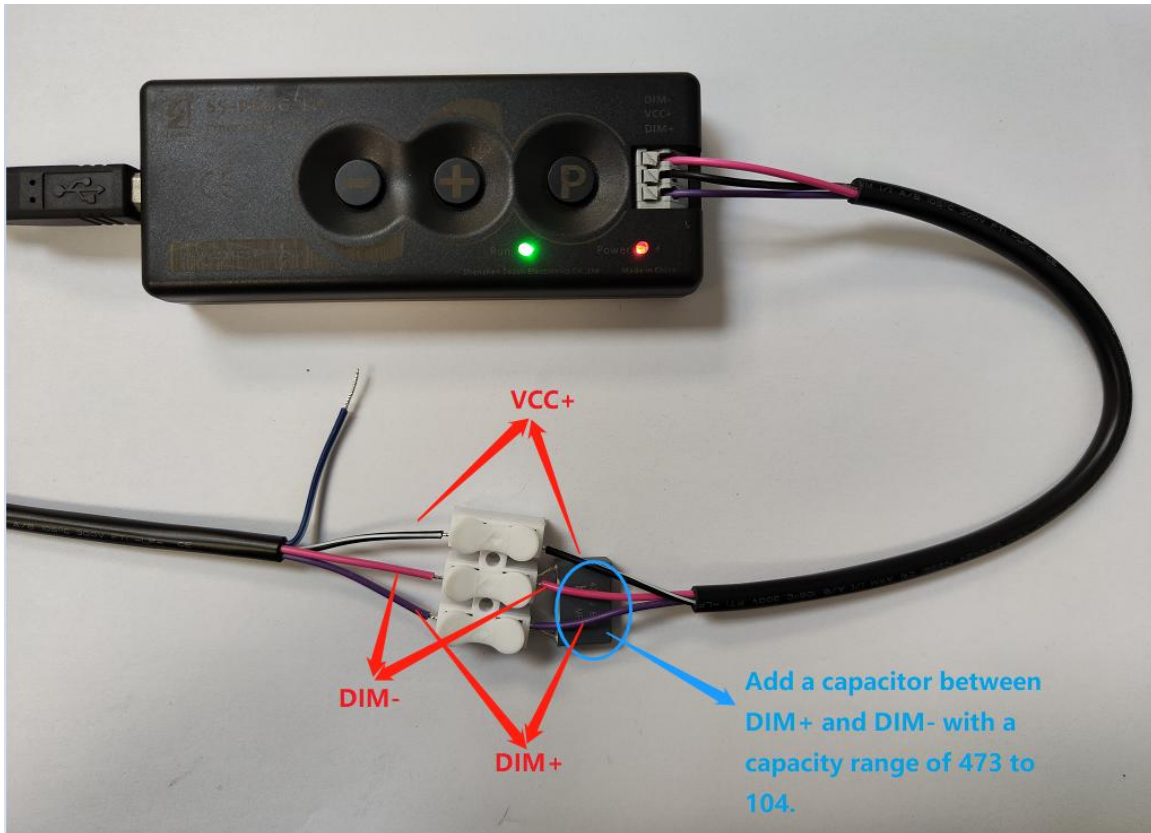

Please confirm that the above operation steps are correct, and then perform the following operations.

3. Software installation and use

3.1. Operating system requirements

Supports Windows 7, Windows 8, Windows 10, Windows 11.

3.2. Software installation

3.2.1. Software decompression

Extract the software package to the appropriate location, go to the software folder

and send the shortcut to the desktop.

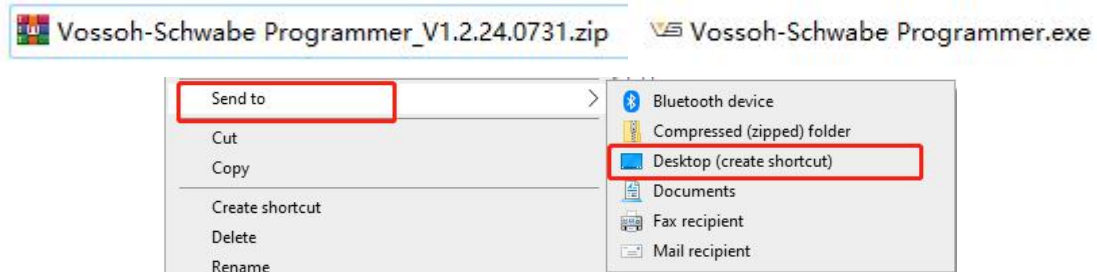

3.2.2. Driver installation

Open the Vossoh-Schwabe Programmer software and click Connect. When the USB Serial Port (COM x) is not displayed at the port, click "Install USB Driver" and the USB driver will be installed.

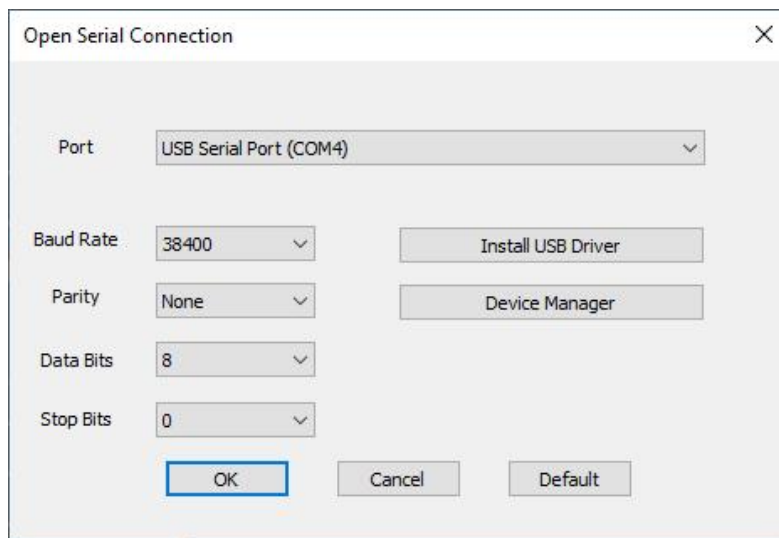

3.3. Functional description of the software

3.3.1. Software main interface

After "Read LED Driver" or "Load Default Values". Displays the features that the model has, orange for the functions that have been enabled, and gray for the functions that

are not enabled.

Vossloh-Schwabe Programmer V1.2.24.0731

File Connect Languages Help

Connect

Disconnect

Diagnose

Read Programmer

Write Programmer

Read LED Driver

Write LED Driver

ECXd 4160.717

Work Current Setting

Output Current: 1.000 A
 Max Output Current: 2.000 A
 Min Output Current: 0.000 A

Output Voltage: 100.0 V
 Max Output Voltage: 100.0 V
 Min Output Voltage: 100.0 V

Max Output Current: 1.0 A

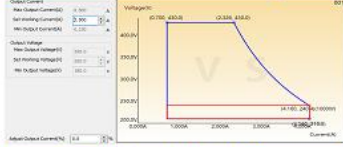

3in1 Dimming

Dimming Curve

Dimming Level (%) vs Dimming Voltage (V)

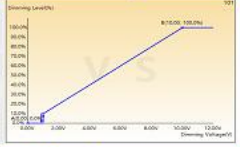

Timer Dimming

Dimming Level (%) vs Time (min)

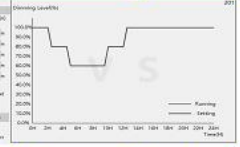

Soft Start Adjustable

Output Power (%) vs Start Time (ms)

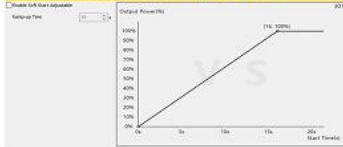

End Life Alarm

Output Power (%) vs Start Time (ms)

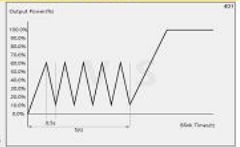

Constant Lumen Output

Output Power (%) vs Start Time (ms)

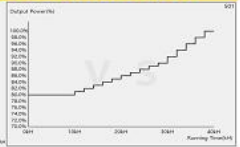

NTC Protection

Output Power (%) vs Temperature (°C)



Disconnected Programmer:No Model LED Driver:No Model

3.3.2. Window area description

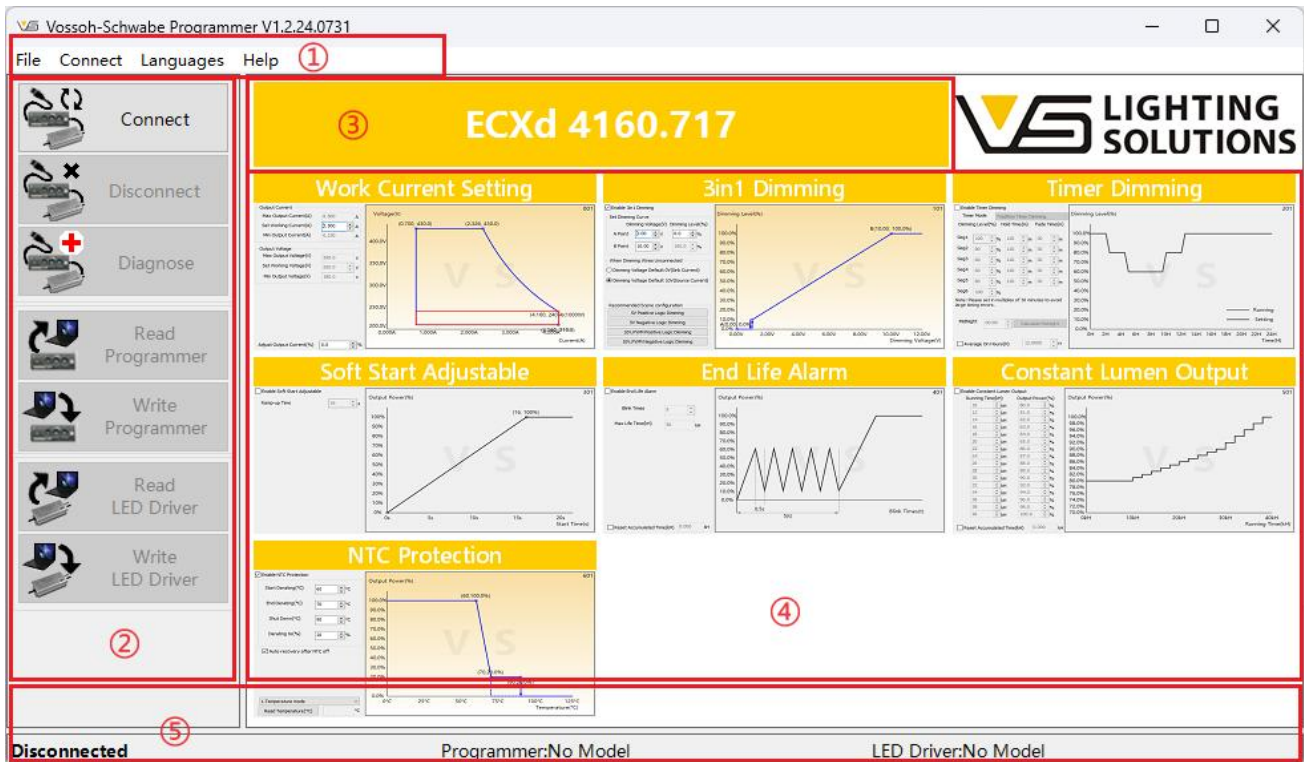

① Menu bar: With the function of saving and opening the model data file, switching languages, opening the user manual, upgrading software and so on.

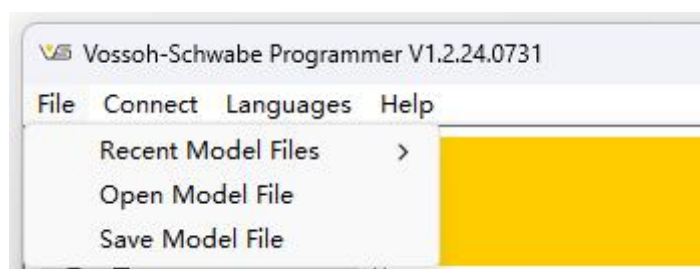

Open Model File: Loads the saved model file from a folder.

Save the model file: Save the loaded model as a data file, and the next time you can directly load the saved data by "Opening Model File".

② Operation bar: Operates the programmer and LED driver.

- ③ Load default values and display model names: Left mouse button opens the model list and displays the model name.
- ④ Function Settings: Set the parameters of the current page of this model.
- ⑤ Model name display: Displays the operating status, the model saved by the current programmer and the model of the LED driver access.

3.4. Programmer firmware upgrade

(1) Automatic detection of upgrades: the programmer is connected to the LED driver and then connected to the computer. Click "Connect" and the Vossoh-Schwabe Programmer software will automatically detect the programmer version and pop up the box to indicate if an upgrade is required. When a new version of the programmer is available, a box prompts you to upgrade the new version.

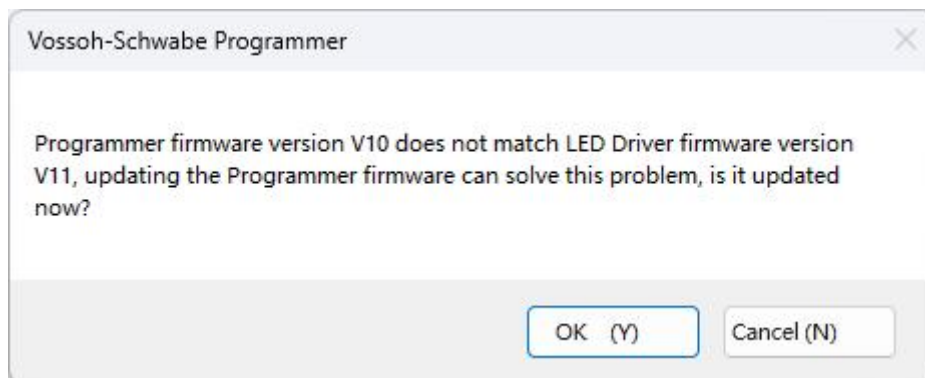

(2) Manual upgrade: Plug the programmer into the computer, connect to the Vossoh-Schwabe Programmer software, click "Diagnose", click to "Upgrade Programmer Firmware", click "Select Firmware". In the "Vossoh-Schwabe Programmer_V1.x.xx.xxx \ Firmware" folder, find the firmware package that needs to

be upgraded, click "Start Upgrade", and wait for the upgrade to complete (do not power off the programmer during the upgrade process).

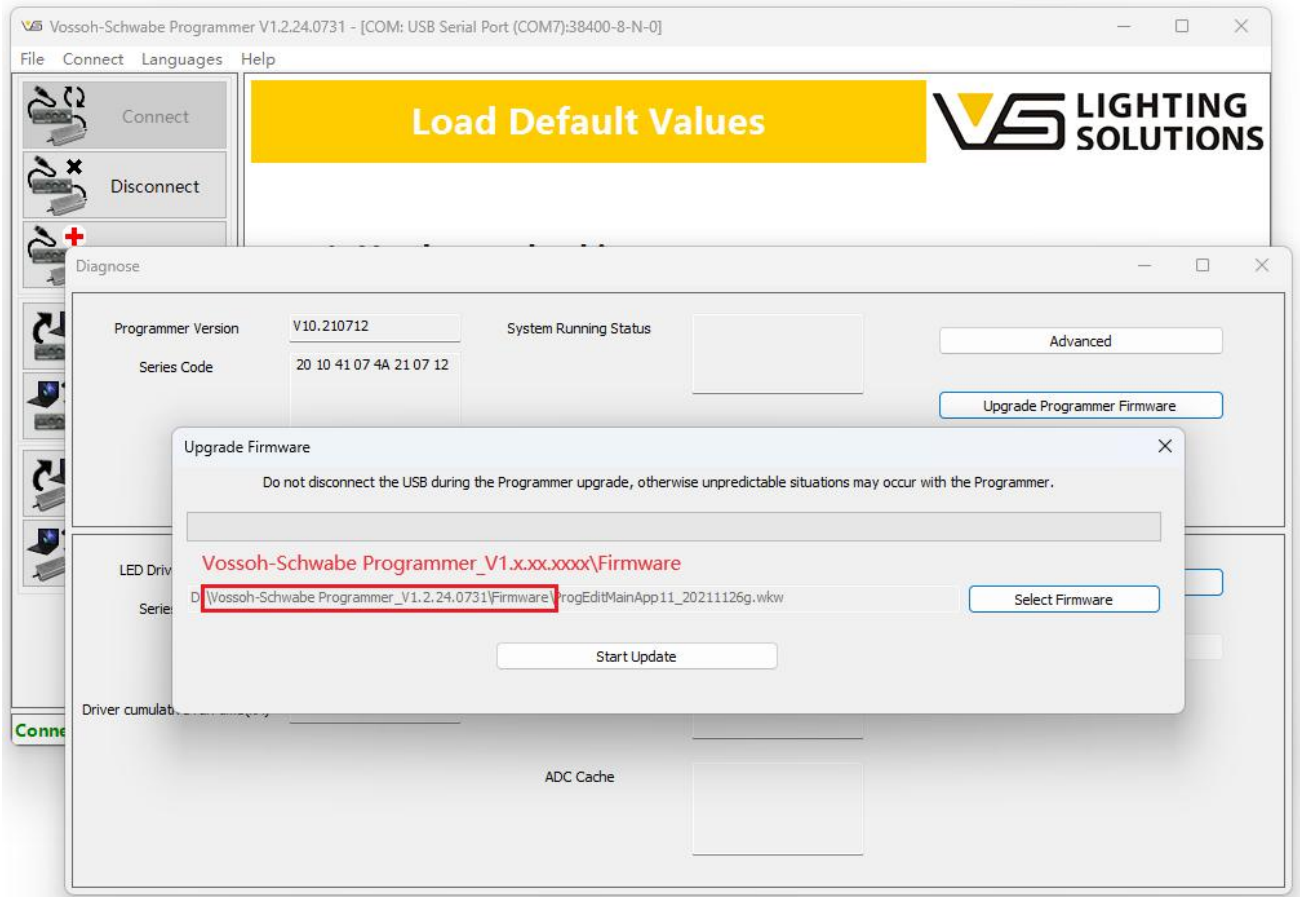

3.5. Online programming and offline programming

When writing to the LED driver, make sure that the model selected is the same as the model of the connected LED driver. If the model is different, the programmer will refuse to program and report an error.

3.5.1. Online programming

Online programming operation method: **Open " Vossoh-Schwabe Programmer" -> Connect -> Read LED Driver / Load Default Values ->**



modify data -> Write LED Driver

Connect: Click "Connect", the serial connection dialog box will pop up, select the correct COM port (USB Serial Port (COM x)).

Read LED Driver: Reads all data from the connected LED driver and refreshes the Vossoh-Schwabe Programmer software interface.

Load Default Values: If you want to restore the default parameters of the model, you can click "Load Default Values", select the correct model, and load the default data into the software interface.

Write LED Driver: Write the set working current data, 3in1 dimming, timer dimming and other parameters to the LED driver.

Note: When writing to the LED driver or reading the LED driver, do not set the Vossoh-Schwabe Programmer software parameters, there may be incorrect parameters written or read.

3.5.2. Offline programming

① Make an offline programmer

Making offline programming method: **Open " Vossoh-Schwabe Programmer" -> Connect -> Read LED Driver / Load Default Values ->**

modify data -> Write Programmer

The first four steps are the same as online programming, and the last step is to write Programmer to prepare the offline Programmer of this model.



② Batch programming

Offline programming method: **Made offline programmer -> USB power supply -> press the "P" key to program**

The model number of the writer programmer must be the same as the model of the LED driver for the write to succeed. If the models are different, the programmer will refuse to program and alarm.

Press the "P" key to program the LED driver. After programming is complete, replace the other LED drivers that are ready for programming and repeat this operation.

4. Introduction to programmable LED driver functions

4.1. Programmable LED driver functions

- (1) Work Current Setting (Current and voltage can be set)
- (2) 3in1 Dimming (Compatible with PWM dimming, 0-5V, 0-10V, etc.)
- (3) Timer Dimming (Traditional Timer Dimming, Self-Adapt-Midnight Timer, Self-Adapt-Percentage Timer)
- (4) Software Start Adjustable (turns on gradually brightening)
- (5) End Life Alarm (Reminder to replace the LED driver)
- (6) Constant Lumen Output (LED lamp pearl attenuation compensation)
- (7) NTC Protection (LED module over-temperature protection function)
- (8) OTP Protection (LED driver over-temperature protection function)

4.2. Programmable LED driver functions explained in detail

4.2.1. Work Current Setting

The output current of the LED driver can be freely adjusted, and the parameters obtained by the LED driver are read by the programmer and displayed on the programming software interface. Modify the current parameter at the set operating current to change the output current of the LED driver. Modifying the parameters at the set operating voltage can reduce the operating voltage of the LED driver.

Fine-tune the output current, for the programmed current data and the actual output current of the LED driver error, the input error ratio, you can get the accurate current parameters (according to the maximum output current of the LED driver is the calculation base).

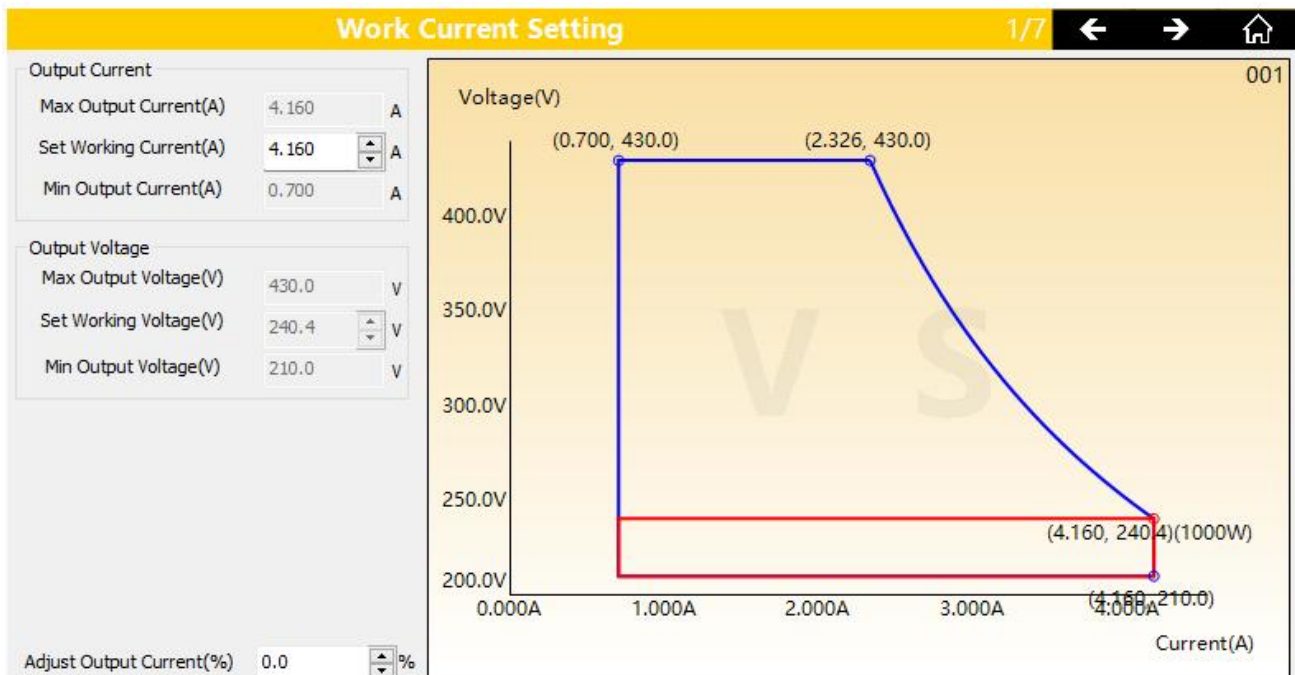

4.2.2. 3in1 Dimming

Set 3in1 Dimming (PWM dimming integrated into 0-10V dimming). The dimming voltage of point A and the dimming voltage of point B can be adjusted according to actual use and can be used in recommended scenarios. Dimming is suspended, and the output voltage of the dimming light can be set (only the hardware support of some LED drivers). Set the dimming level of point A to the minimum dimmable brightness (if the dimming level of point A is set to 100%, the dimming will not respond).

The off voltage and on voltage are set on the Model Parameters page.

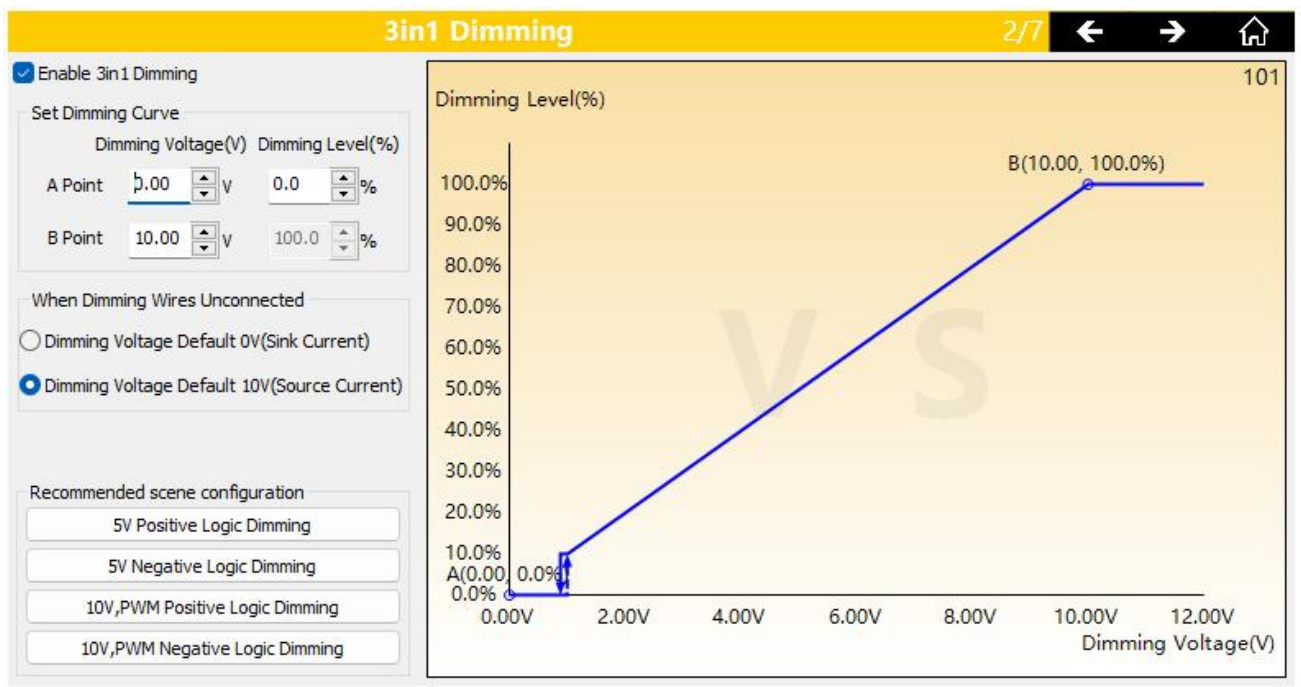

4.2.3. Timer Dimming

Traditional Timer Dimming, Self-Adapt-Midnight Timer, Self-Adapt-Percentage Timer. Time-controlled dimming settings can be made by setting 6 curves.

Traditional Timer Dimming: After the LED driver is powered on, it works according to the set dimming curve (adding a gradient time can slowly change between different dimming levels to prevent sudden changes in brightness and cause glare).

Self-Adapt-Midnight Timer: The 4th segment of the adaptive midnight timer curve acts as the midnight point. The LED driver automatically saves the effective power-on time and automatically calculates the adaptive cycle time through the effective calculation time of 4 times.

Self-Adapt-Percentage Timer: The adaptive percentage runs according to the automatically calculated adaptive cycle time according to the initially set dimming curve.

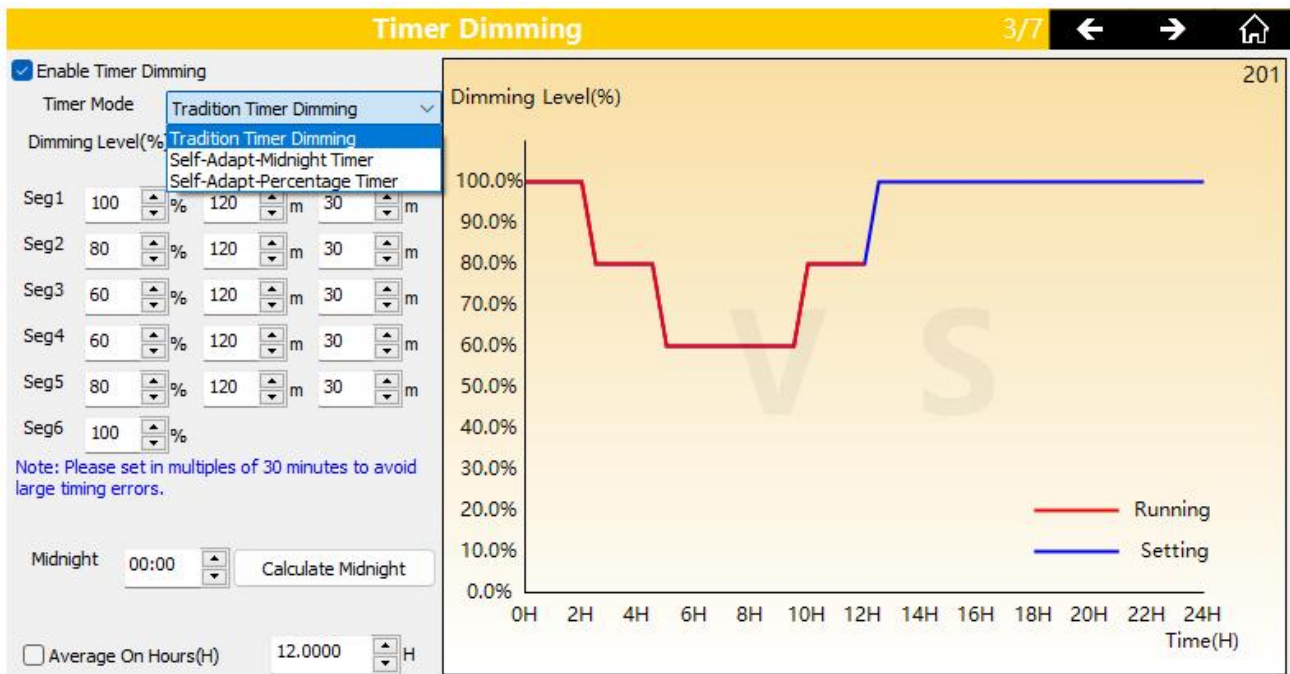

4.2.4. Software Start Adjustable

The LED driver start-up time can be programmed and set arbitrarily from 1 second to

255 seconds. Applicable scenes such as road lighting, tunnel lighting, square lighting, stadium lighting, plant lighting, etc. Can effectively prevent the process of turning on the lights, the lamp suddenly lit up, causing glare to people, causing traffic accidents. When multiple LED drivers are turned on at the same time, it can effectively prevent the AC line load power consumption from being too large at the moment of boot, and achieve the effect of protecting the AC line.

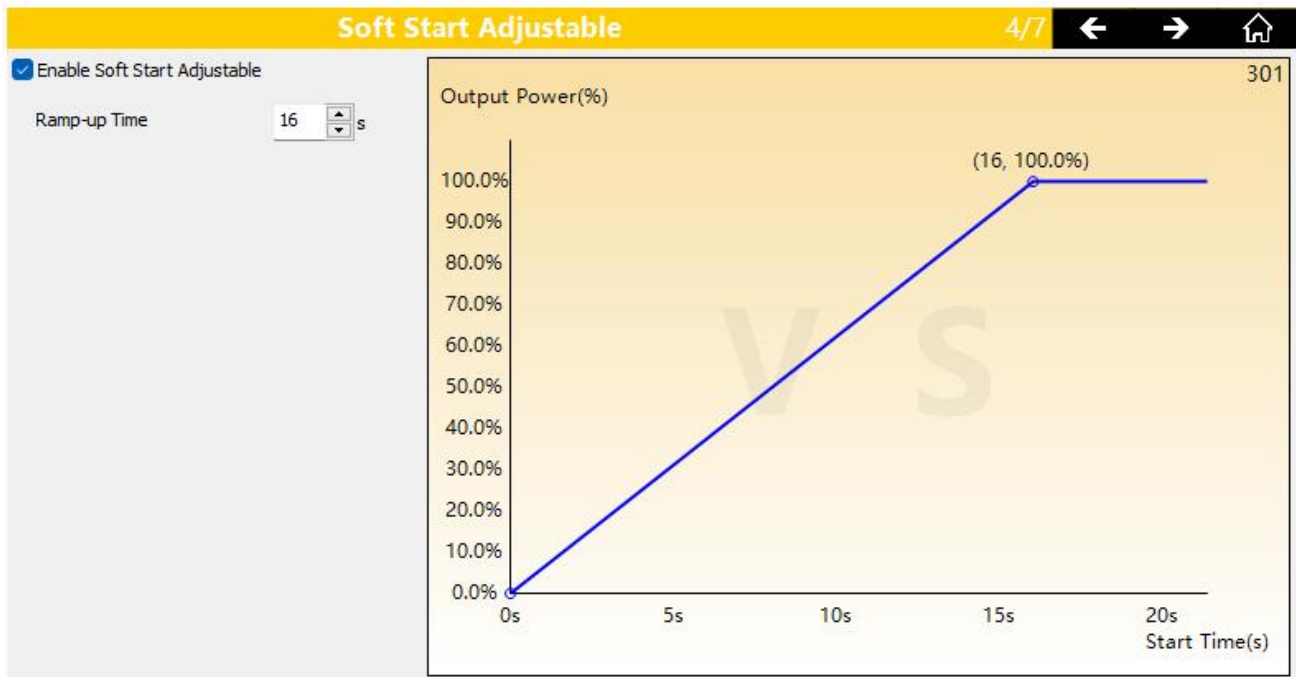

4.2.5. End Life Alarm

By presetting an LED driver life time, such as 50KH life, when the luminaire use time accumulates more than 50KH, the lamp will flash 5 times every time the lamp is turned on, reminding the user to replace the LED driver.

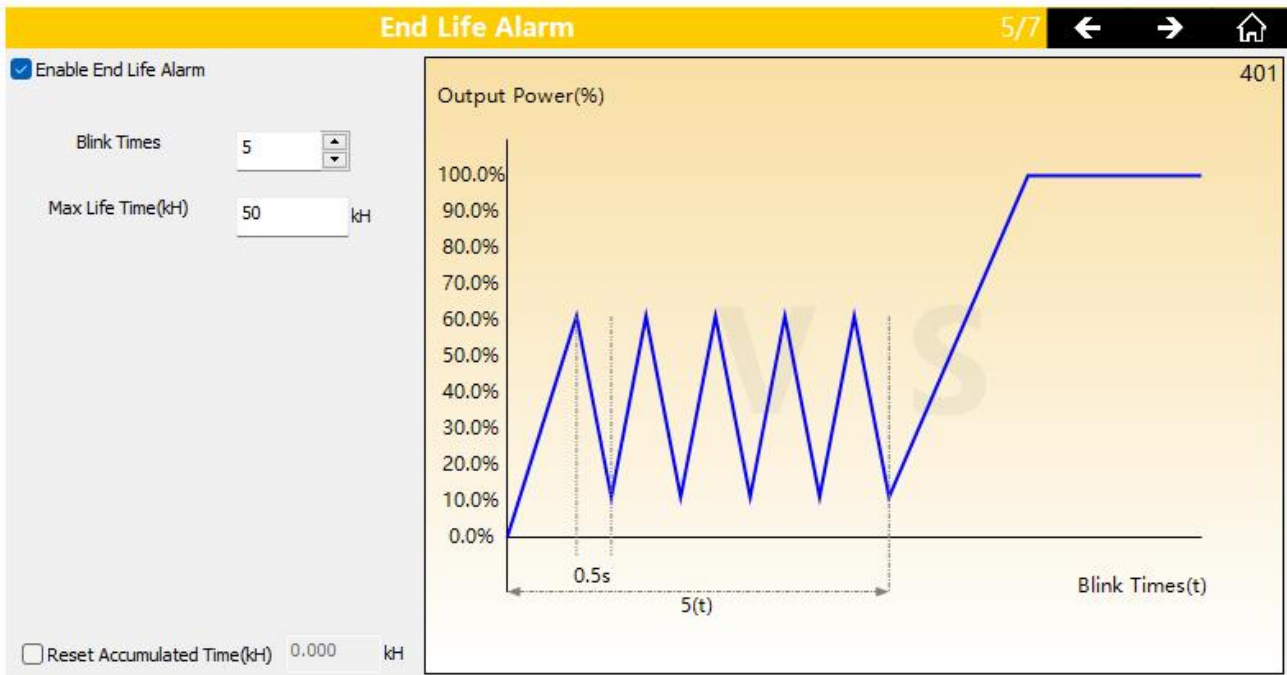

4.2.6. Constant Lumen Output

Light decay compensation function, according to the LED lamp light decay curve, in the life cycle of the lamp, by gradually increasing the output current, to achieve a constant output of LED luminous flux, the overall luminous effect remains unchanged.

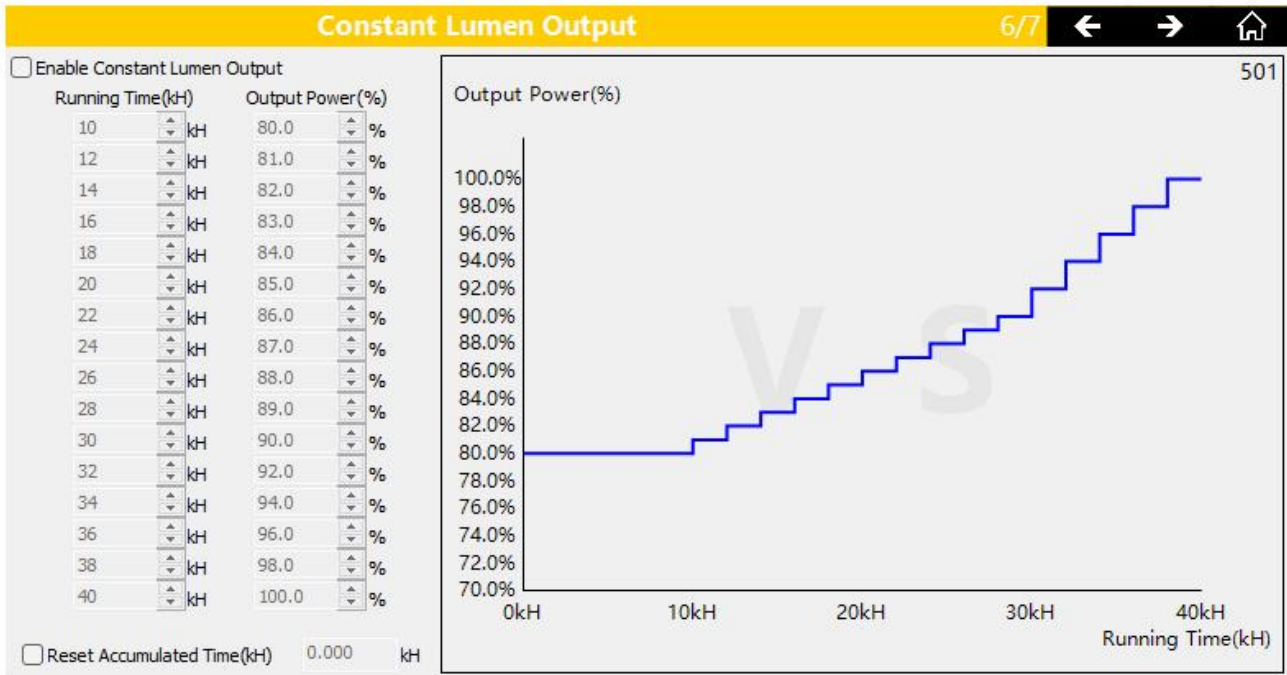

4.2.7. NTC Protection

At the LED driver end, a wire is connected to the NTC temperature control switch sensor to feed the temperature on the LED module to the internal controller of the LED driver.

Note: The LED driver hardware must support NTC functionality.

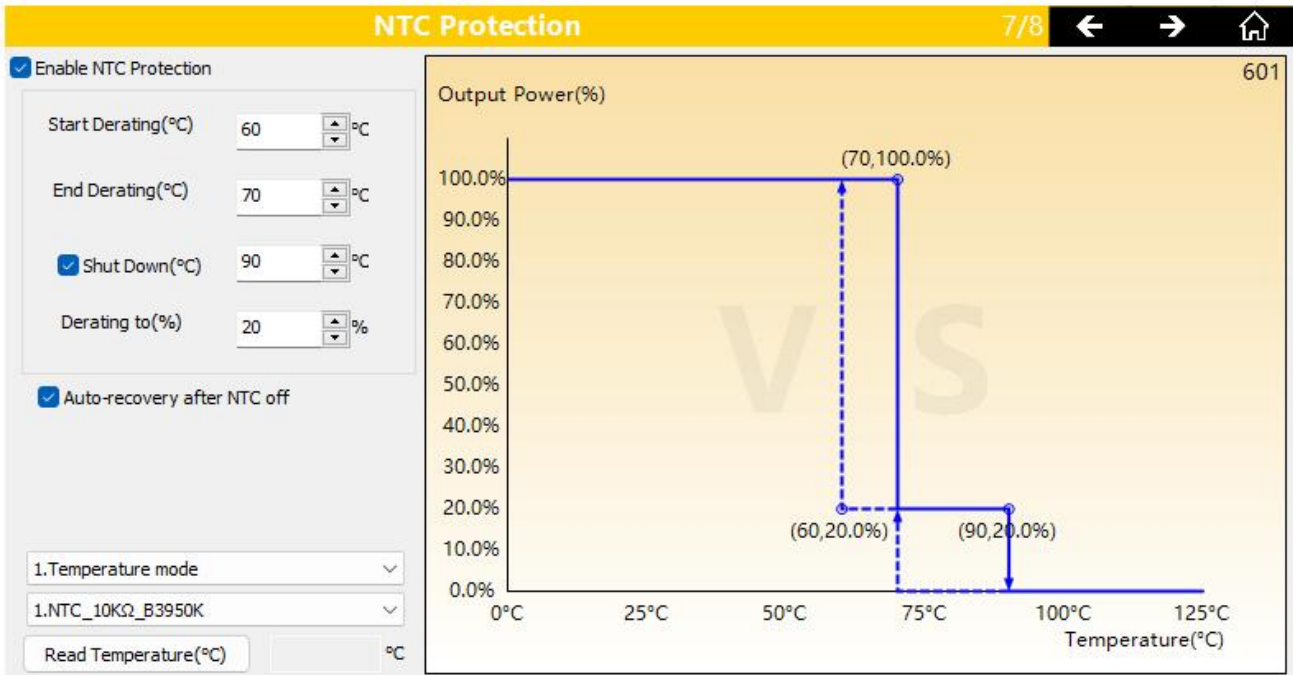

Figure 1

A thermistor "temperature-resistance" mapping table is attached.

10KΩ_B3950K		10KΩ_B3435K		10KΩ_B3380K	
Temperature °C	Resistance KΩ	Temperature °C	Resistance KΩ	Temperature °C	Resistance KΩ
0	32.7547	0	27.4936	0	27.2186
1	31.1243	1	26.3245	1	26.076
2	29.5847	2	25.2119	2	24.9877
3	28.1301	3	24.1527	3	23.9509
4	26.7556	4	23.1442	4	22.9629
5	25.4562	5	22.1835	5	22.0211
6	24.2274	6	21.2682	6	21.123
7	23.065	7	20.3959	7	20.2666
8	21.965	8	19.5644	8	19.4495
9	20.9239	9	18.7714	9	18.6698
10	19.938	10	18.0151	10	17.9255
11	19.0041	11	17.2935	11	17.2139
12	18.1193	12	16.6048	12	16.5344
13	17.2807	13	15.9475	13	15.8856



14	16.4857	14	15.3198	14	15.2658
15	15.7317	15	14.7203	15	14.6735
16	15.0164	16	14.1475	16	14.1075
17	14.3376	17	13.6003	17	13.5664
18	13.6933	18	13.0772	18	13.0489
19	13.0816	19	12.5771	19	12.554
20	12.5005	20	12.0988	20	12.0805
21	11.9485	21	11.6413	21	11.6281
22	11.4239	22	11.2037	22	11.1947
23	10.9252	23	10.7848	23	10.7795
24	10.451	24	10.3839	24	10.3815
25	10	25	10	25	10
26	9.5709	26	9.6324	26	9.6342
27	9.1626	27	9.2802	27	9.2835
28	8.7738	28	8.9428	28	8.947
29	8.4037	29	8.6195	29	8.6242
30	8.0512	30	8.3096	30	8.3145
31	7.7154	31	8.0124	31	8.0181
32	7.3953	32	7.7275	32	7.7337
33	7.0903	33	7.4541	33	7.4609
34	6.7995	34	7.1919	34	7.1991
35	6.5221	35	6.9403	35	6.9479
36	6.2576	36	6.6987	36	6.7067
37	6.0051	37	6.4669	37	6.4751
38	5.7642	38	6.2442	38	6.2526
39	5.5342	39	6.0304	39	6.039
40	5.3146	40	5.825	40	5.8336
41	5.1049	41	5.6276	41	5.6357
42	4.9045	42	5.438	42	5.4454
43	4.713	43	5.2557	43	5.2623
44	4.53	44	5.0804	44	5.0863
45	4.3551	45	4.9119	45	4.9169
46	4.1878	46	4.7498	46	4.7539
47	4.0278	47	4.5939	47	4.5971
48	3.8748	48	4.4439	48	4.4461
49	3.7283	49	4.2995	49	4.3008
50	3.5882	50	4.1605	50	4.1609
51	3.454	51	4.0268	51	4.0262
52	3.3255	52	3.898	52	3.8964
53	3.2025	53	3.7739	53	3.7714
54	3.0846	54	3.6544	54	3.651



55	2.9717	55	3.5393	55	3.535
56	2.8635	56	3.4284	56	3.4231
57	2.7597	57	3.3215	57	3.3152
58	2.6603	58	3.2185	58	3.2113
59	2.5649	59	3.1191	59	3.111
60	2.4734	60	3.0234	60	3.0143
61	2.3856	61	2.931	61	2.9224
62	2.3014	62	2.8419	62	2.8337
63	2.2206	63	2.7559	63	2.7482
64	2.1431	64	2.6729	64	2.6657
65	2.0686	65	2.5929	65	2.5861
66	1.997	66	2.5156	66	2.5093
67	1.9283	67	2.441	67	2.4351
68	1.8623	68	2.369	68	2.3635
69	1.7989	69	2.2994	69	2.2943
70	1.738	70	2.2322	70	2.2275
71	1.6794	71	2.1673	71	2.1627
72	1.6231	72	2.1046	72	2.1001
73	1.5689	73	2.044	73	2.0396
74	1.5168	74	1.9854	74	1.9811
75	1.4667	75	1.9288	75	1.9245
76	1.4185	76	1.874	76	1.8698
77	1.3722	77	1.8211	77	1.817
78	1.3275	78	1.7699	78	1.7658
79	1.2845	79	1.7204	79	1.7164
80	1.2431	80	1.6725	80	1.6685
81	1.2033	81	1.6262	81	1.6224
82	1.1649	82	1.5813	82	1.5777
83	1.1279	83	1.5379	83	1.5345
84	1.0923	84	1.4959	84	1.4927
85	1.058	85	1.4553	85	1.4521
86	1.0249	86	1.4159	86	1.4129
87	0.993	87	1.3778	87	1.3749
88	0.9623	88	1.3408	88	1.3381
89	0.9326	89	1.3051	89	1.3025
90	0.904	90	1.2704	90	1.268
91	0.8764	91	1.2368	91	1.2343
92	0.8498	92	1.2043	92	1.2016
93	0.8241	93	1.1728	93	1.17
94	0.7994	94	1.1422	94	1.1393
95	0.7754	95	1.1126	95	1.1096



96	0.7523	96	1.0839	96	1.0807
97	0.73	97	1.056	97	1.0528
98	0.7085	98	1.029	98	1.0256
99	0.6877	99	1.0028	99	0.9993
100	0.6676	100	0.9774	100	0.9738
101	0.6482	101	0.9527	101	0.9492
102	0.6295	102	0.9288	102	0.9254
103	0.6113	103	0.9055	103	0.9022
104	0.5938	104	0.883	104	0.8798
105	0.5769	105	0.8611	105	0.858
106	0.5605	106	0.8399	106	0.8368
107	0.5447	107	0.8193	107	0.8162
108	0.5293	108	0.7992	108	0.7963
109	0.5145	109	0.7798	109	0.7769
110	0.5002	110	0.7609	110	0.758
111	0.4863	111	0.7425	111	0.7397
112	0.4729	112	0.7247	112	0.7219
113	0.4599	113	0.7074	113	0.7046
114	0.4474	114	0.6906	114	0.6878
115	0.4352	115	0.6742	115	0.6715
116	0.4234	116	0.6583	116	0.6556
117	0.412	117	0.6429	117	0.6402
118	0.4009	118	0.6278	118	0.6252
119	0.3902	119	0.6132	119	0.6106
120	0.3799	120	0.599	120	0.5964
				121	0.5826
				122	0.5692
				123	0.5562
				124	0.5435
				125	0.5311

4.2.8. Model Parameters

The model parameters page can set the dimming on voltage and dimming off voltage of the LED driver, as well as other parameters (the setting of the dimming on voltage

and dimming off voltage requires hardware support).

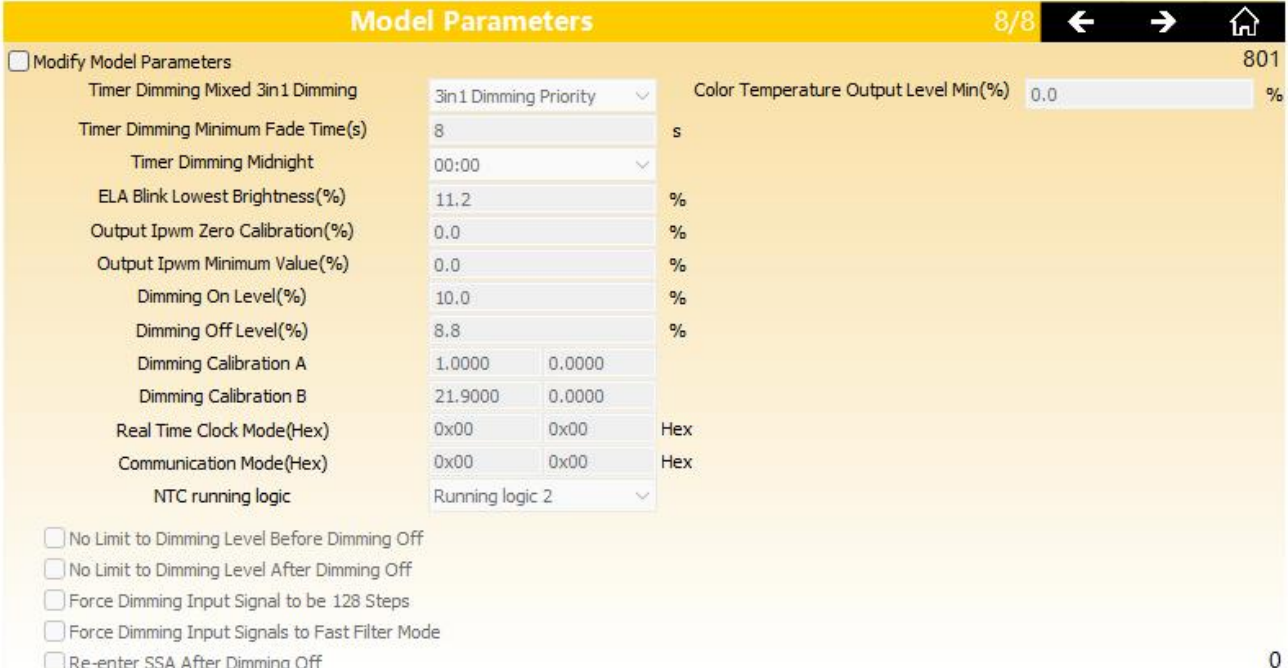

Model Parameters 8/8

Modify Model Parameters

Timer Dimming Mixed 3in1 Dimming	3in1 Dimming Priority	Color Temperature Output Level Min(%)	0.0	%
Timer Dimming Minimum Fade Time(s)	8			s
Timer Dimming Midnight	00:00			
ELA Blink Lowest Brightness(%)	11.2			%
Output Ipwm Zero Calibration(%)	0.0			%
Output Ipwm Minimum Value(%)	0.0			%
Dimming On Level(%)	10.0			%
Dimming Off Level(%)	8.8			%
Dimming Calibration A	1.0000	0.0000		
Dimming Calibration B	21.9000	0.0000		
Real Time Clock Mode(Hex)	0x00	0x00		Hex
Communication Mode(Hex)	0x00	0x00		Hex
NTC running logic	Running logic 2			

No Limit to Dimming Level Before Dimming Off
 No Limit to Dimming Level After Dimming Off
 Force Dimming Input Signal to be 128 Steps
 Force Dimming Input Signals to Fast Filter Mode
 Re-enter SSA After Dimming Off

801

0

4.3. Introduction to the adaptive timer function

4.3.1. Adaptive timer function application

Vossoh-Schwabe's adaptive timer function takes into account the use of lamps and lanterns in different regions and different seasons. The LED driver automatically calculates the runtime in a "self-learning" manner, corresponding to the timer dimming curve set at the time of initial installation, to achieve adaptive timing dimming function. The timer dimming curve only needs to be set once before installation. Vossoh-Schwabe's adaptive timer dimming function consists of 2 modes: "Self-Adapt-Midnight Timer" and "Self-Adapt-Percentage Timer".

4.3.2. Adaptive time calculation

(1) Manually switch on and off the machine at least once a day

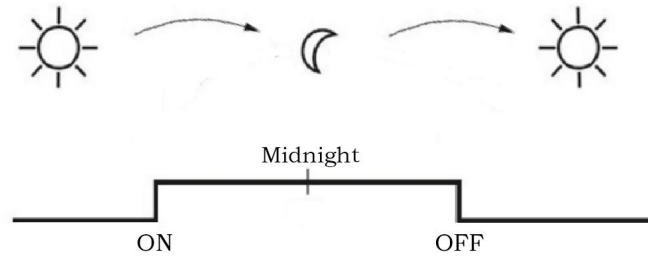

(2) The effective run time is calculated automatically

- a. The power-on running time is not less than 2 hours, and it is recorded as 1 effective running time.
- b. The LED driver power-down time is not less than 1s, which will be recorded as a new time.
- c. The difference between the most recent effective running time and the absolute value of the effective running time in front of it is not more than 1 hour, which is the valid calculation data. 4 valid calculations to get "Average On Hours" (AOH).

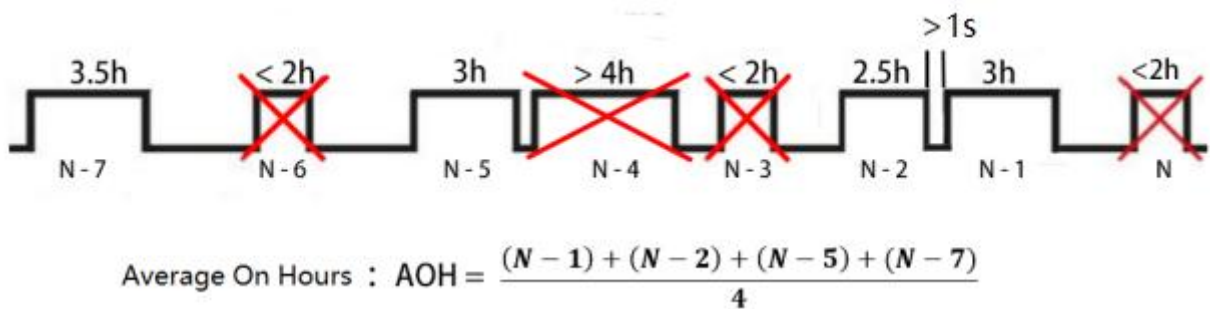

4.3.3. Adaptive timer dimming

(1) Self-Adapt-Midnight Timer

- a. Use the starting point set in the 4th segment of the dimming curve as the adaptive midnight point.

b. Then according to "Average On Hours" (AOH), it corresponds to both sides of midnight. The red line is the change in power output when the LED driver is running.

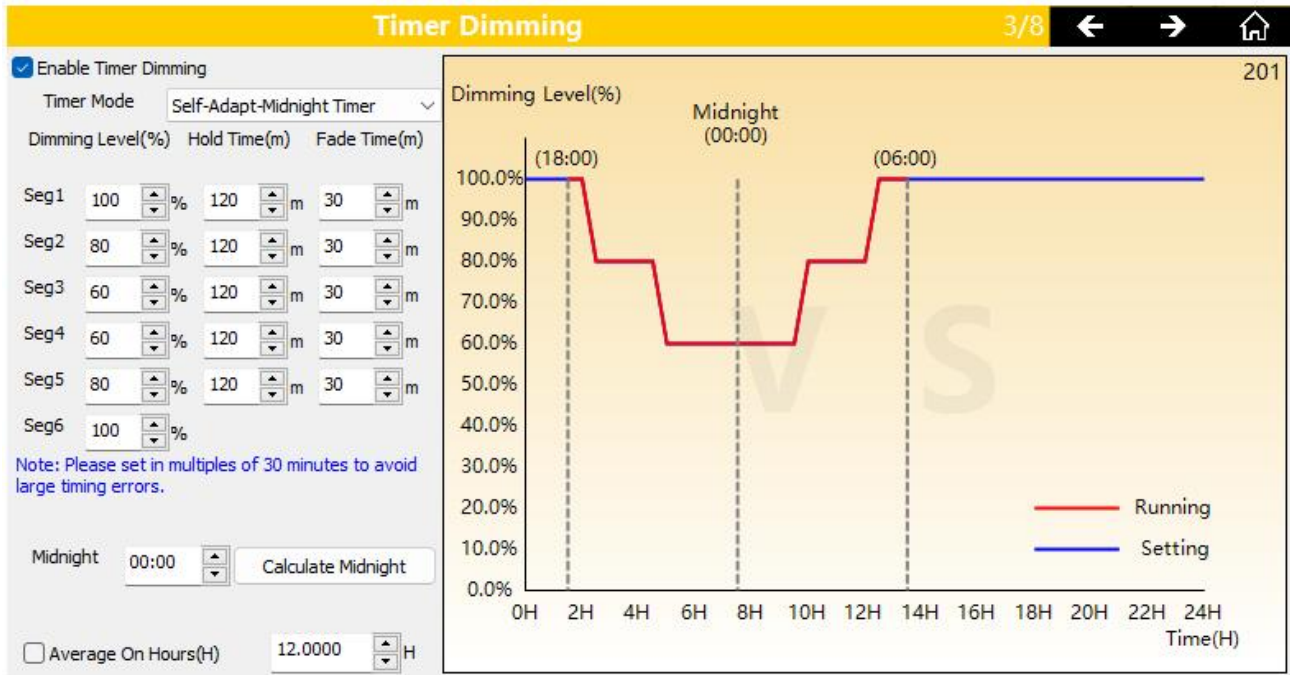

(2) Self-Adapt-Percentage Timer

According to the percentage ratio of "Average On Hours" (AOH), the time of setting the curve is converted proportionally to obtain the LED driver running output change curve

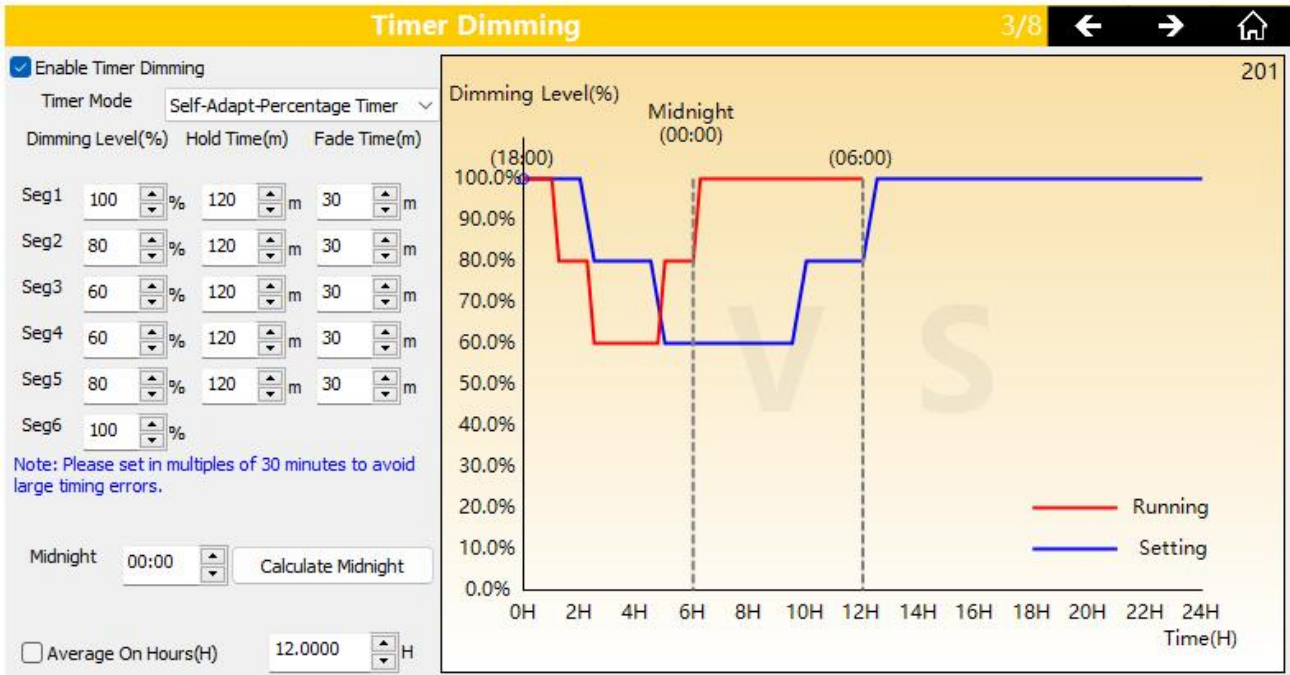

Versions	Date	Description
V1.00	2022/02/11	Initial release
V1.01	2022/04/11	Fixed some page display
V1.1	2022/10/13	Add some features
V1.2	2023/04/25	Added new communication methods for models.